

# Control over spectral content via differential pumping of a monolithic passively mode-locked quantum dot laser

K. Brown<sup>a</sup>, B. Wysocki<sup>a</sup>, M. Fanto<sup>a</sup>, J. Malowicki<sup>a</sup>, V. Kovanis<sup>b</sup>, and L. Lester<sup>c</sup>

<sup>a</sup>Air Force Research Lab, Sensors Directorate, Rome Research Site, 25 Electronics Pkwy, Rome, NY 13441

<sup>b</sup>Air Force Research Lab, Sensors Directorate, Wright-Patterson AFB, OH 45433

<sup>c</sup>Center for High Technology Materials, University of New Mexico, Albuquerque, NM 87106

## Abstract

A monolithic two-section quantum dot semiconductor laser is differentially pumped to form non-uniform current injection in the gain region. We show that the nature of the spectral content in the output signal is affected by this differential pumping; despite the fact that the separately pumped gain regions are not electrically isolated in this device. Both negative (red-shift) and positive (blue-shift) spectral chirps were observed during mode-locked operation. It is also demonstrated that mode locked operation is achieved with a much larger set of injection current / absorber bias voltage pairs than was previously possible with single-pad current injection.

**Keywords:** quantum dots, passive mode locking, semiconductor lasers, chirp, differential pumping

## 1. Introduction

Semiconductor lasers utilizing quantum dot (QD) active regions have recently been used to generate stable optical pulses and provide an exceptional platform for the development of compact agile emitters at optical frequencies. QD semiconductor lasers offer low threshold current densities, reduced linewidth enhancement factors, reduced timing jitter, and high modulation bandwidth as compared with bulk or quantum well devices [2]. They show great potential for the generation of short pico-second pulses due to the wide bandwidth of the inhomogeneously broadened gain spectrum. A unique recently developed QD laser has recently enabled exploitation of these strengths through a reconfigurable multisection device [3]. This allows for rapid testing of design concepts while minimizing the required fabrication. Such a device was used in this work to explore the effects of differential gain pumping.

Since the temporal features of a pulse are related to its spectral properties through the Fourier transform, an alteration of a signal's frequency content will affect the temporal pulse shape. We show that differential pumping (nonuniform injection currents into the gain medium) provides a degree of control over the spectral content and bandwidth of the mode-locked laser output. This technique can be used to optimize a particular device's pulse characteristics, such as pulse length or frequency chirp content by appropriate tailoring of the pumping schemes.

## 2. Experiment

A monolithic two-section quantum dot semiconductor laser is differentially pumped in order to explore the effects on spectral content and mode-locking stability. The device being tested operates near 1245 nm and is passively mode-locked at a repetition rate of approximately 5 GHz through the use of a reverse biased saturable absorber as depicted in figure 1.

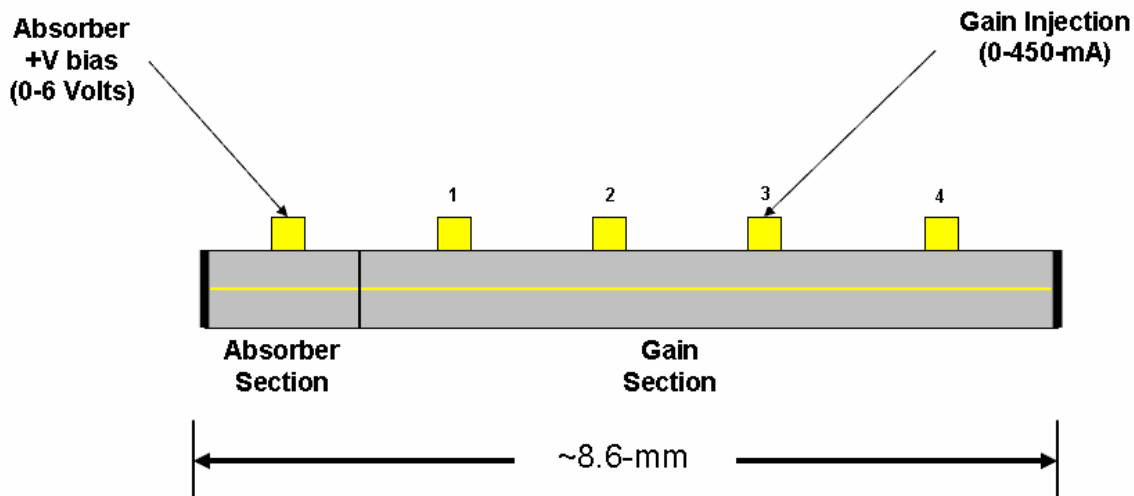

Figure 1: A graphic depicting the device design used during differential pumping. The absorber section is electronically isolated from the gain medium. The tabs on the top of the device represent probe pads.

The gain region is electrically isolated from the absorber section during fabrication by proton implantation, providing a highly resistive barrier of  $>10\text{ M}\Omega$  [1]. The cleaved mirror on the absorber side of the device was coated for high reflection while the mirror adjacent to the gain section was low reflection coated for high output power. The gain region can be probed directly through any or all of the four contact pads located on the device. Although the four regions of the gain section corresponding to each pad were not electrically isolated, they provided the means to pump the gain medium with nonuniform current densities by virtue of the finite resistance of the metal anode between them. Figure 2 shows the experimental configuration used during all testing. Each chip (containing up to 18 devices) was mounted to a TE cooler and maintained at a constant temperature of 25 degrees Celsius. An ILX LDC-3900 4-channel current source controlled both the TE cooler and the injection currents. An Amrel PPS-1202 programmable DC power supply controlled the absorber bias voltage. Both the voltage ramp profile and the current ramp profile are controlled via a LabView script. The laser output is coupled into a single-mode polarization maintaining lensed-tip fiber. An isolator is used to minimize feedback into the cavity of the device. The output of the isolator can be connected to a Femtochrome FR-103XL autocorrelator, an Ando AQ6317B optical spectrum analyzer, or a 50 GHz HP 8565E electronic spectrum analyzer via a New Focus 45 GHz IR optical detector and amplifier. All equipment but the autocorrelator was remotely operated through a LabView script. To measure the average power, an Oriel 70451 four-inch integrating sphere and Newport 883 IR detector were used. The integrating sphere was chosen over complicated coupling optics to ensure the highest possible accuracy when measuring the average output power during experimentation. The integrating sphere and detector were calibrated from a reference source.

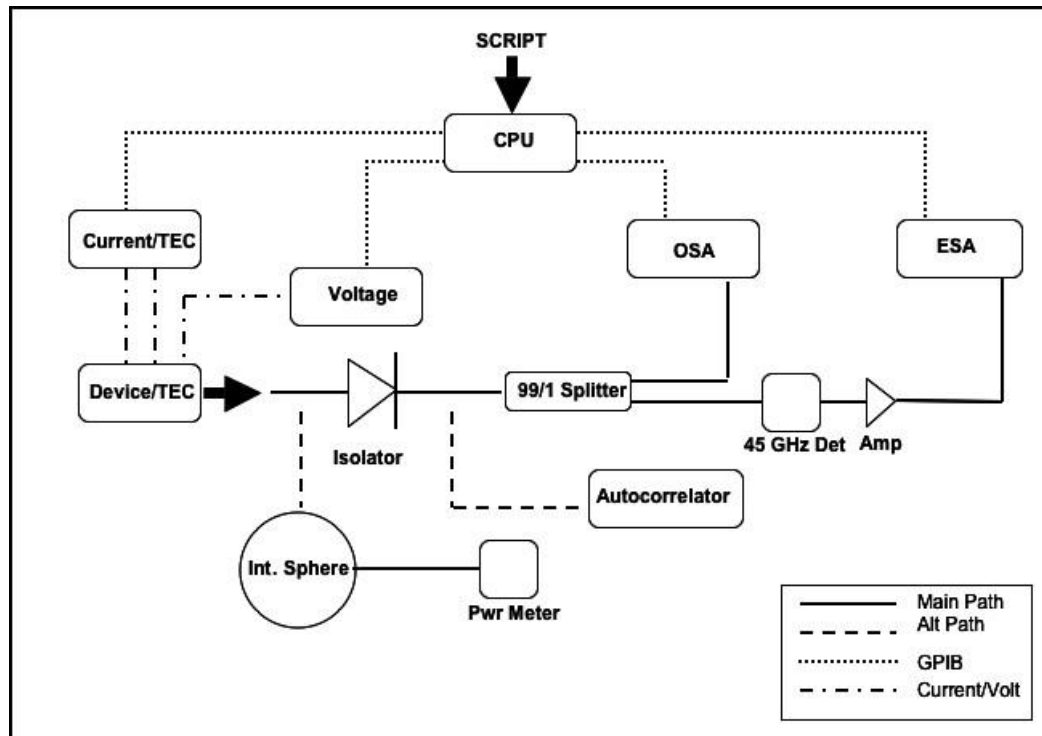

Figure 1. Experiment layout. Device output is coupled into polarization maintaining fiber or directly into an integrating sphere. OSA is optical spectrum analyzer, ESA is electronic spectrum analyzer, and TEC is temperature controller.

The first part of the experiment explores the effects of separately pumping each of the four pads. Each pad was individually injected with 150 mA of current while holding the absorber reverse bias voltage constant at 3 volts. The spectral content of the output was recorded as shown in figure 3. It was demonstrated that pad selection alone has a relevant impact on the optical spectrum. Locking across a continuous spectrum of modes tended to occur at the pad 1 and 2 locations that are closer to the absorber section. However, two sets of locked modes were observed when the pumping was located towards the output facet. The explanation for this behavior is not exactly known at this time but could be related to photon density variation in the cavity and optical non-linearities induced by this phenomenon.

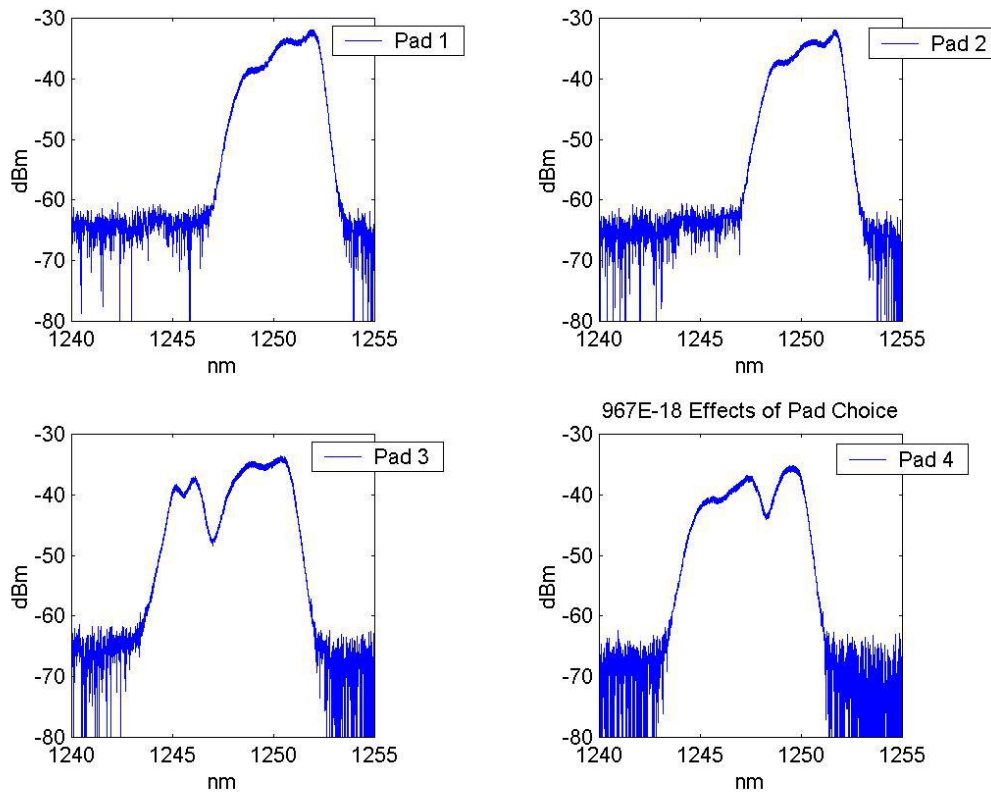

Figure 3: Plots showing the spectral content of the laser's output during single pad current injection of 150 mA at each of the corresponding probe pads. The bias voltage on the absorber was held constant at 3 V. The modulation on the optical spectrum is most likely due to optical modes induced by the transparent GaAs substrate.

In addition to the spectral content, maps showing the stable mode-locking combinations of injection current and bias voltages were generated for each pad. As covered in a previous paper [4], the presence of a strong fourth harmonic in the electronic spectrum was used as the indication of good mode-locking. The map data was recorded as the current and reverse voltages were varied over their respective ranges of 0-200 mA in 10 mA increments and 0 to 6 volts in increments of 0.25. The results are shown in figure 4. Pads one and four show comparable regions of mode-locked operation and are similarly limited to a bias voltage of around 4 volts. Pads two and three which are located towards the inner region of the gain section allow for additional pulse shaping possibilities by providing mode-locked output at reverse bias voltages reaching nearly six volts. Utilization of this available increase in absorber bias allows for a reduced minimum recovery time and thus, a minimized pulse width. The threshold current was not found to vary significantly based on pad selection.

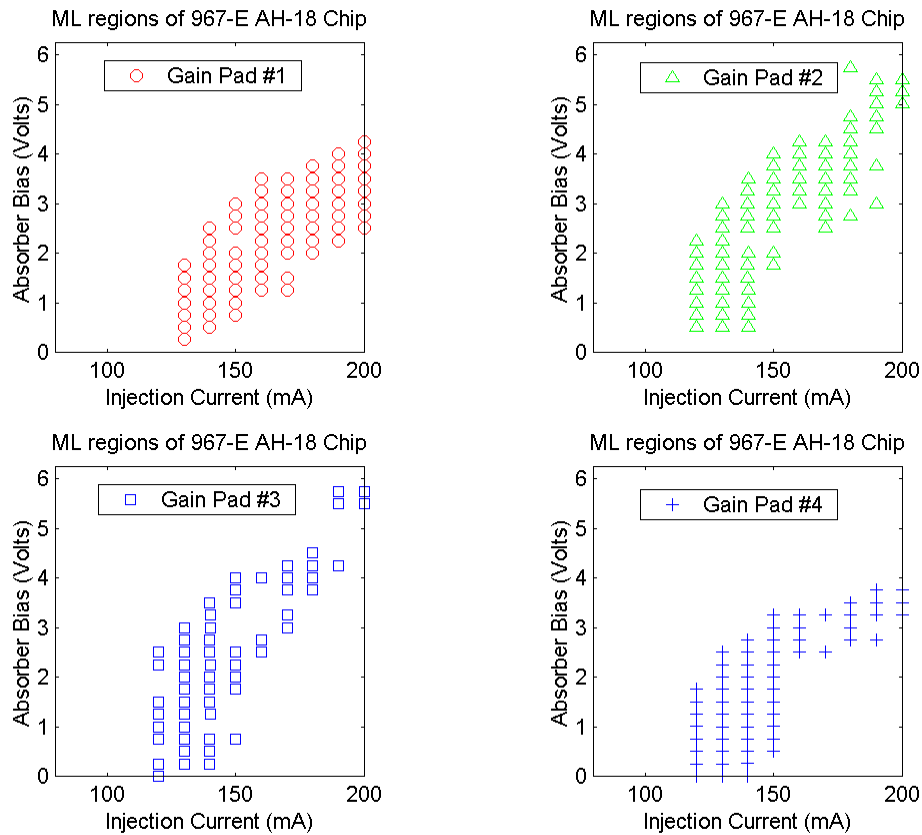

Figure 4: The mode-locked regions of operation for the device as a function of injection current and absorber bias voltage. Note how the available range of bias voltages that allow mode-locking is expanded for the inner pads (2 and 3) when compared to the pads on the outer regions of the gain section (1 and 4).

Good mode-locking was also observed with reverse bias voltages as high as 6.5 volts when pad 1 was pumped with 165-175 mA and pad 4 was simultaneously pumped with 35-25 mA, further expanding on the quality mode-locking region when compared to single pad pumping. It should be noted that when evaluating these devices, it is important to not only know where the device mode-locks, but also the quality of the mode-locking.

The spectral effects of differentially pumping two pads simultaneously were also of interest. Figure 5 shows how the shape of the optical spectrum can be controlled and broadened in an attempt to influence the pulse characteristics. In this experiment both the injection currents (pads 1 and 4) and the bias voltage were altered in order to produce symmetric spectrums of differing breadth. During experimentation, both positive and negative spectral chirps were observed. The authors plan to expand this research to include the effects of differential pumping on pulse shape through the use of frequency resolved optical gating with the hope that the broader spectrums achieved through differential pumping will allow for shorter pulse generation. Whether or not this technique can be used as a tool to manipulate pulse shape is the focus of further investigation.

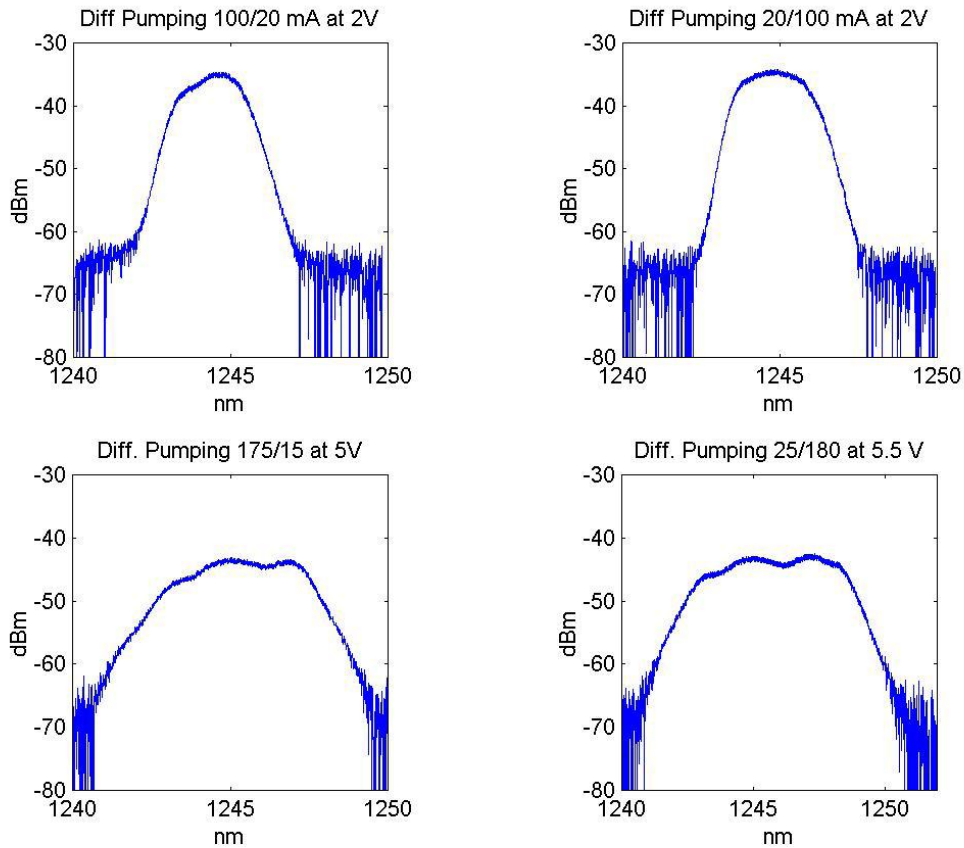

Figure 5: Plots of the optical spectrum from a single device under separate differential pumping schemes. The injection currents correspond to pads 1 and 4 respectively. Note how the symmetry and width of the spectrums were improved when compared to single pad injection method as shown in figure 3. The modulation on the spectra is most likely due to optical modes induced by the transparent GaAs substrate.

Differentially pumping pads 1 and 4 not only altered the spectrum but had a large impact on average power. The integrating sphere was used to capture the emitted power and was placed directly at the output facet. Figure 6 shows the relationship between differential current injection and average output power. It can be seen that maximum average power was obtained when the current was evenly divided between the pads. This does not necessarily correspond to the highest quality mode-locking and trade offs between high average power and short pulse lengths are necessary.

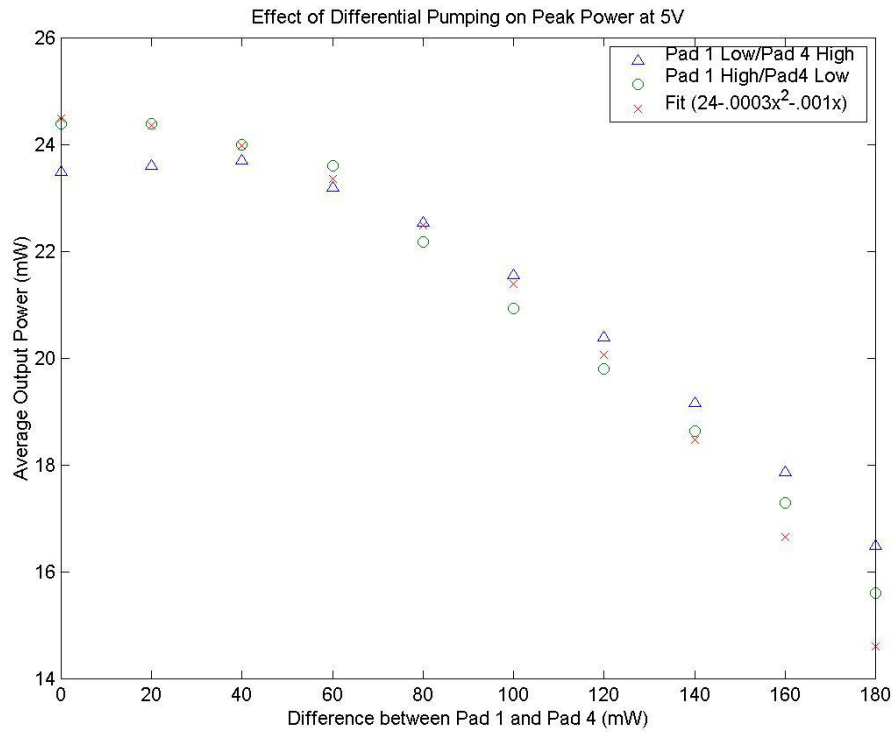

Figure 6: This graph shows the relationship between the differential pumping of pads 1 and 4 with the corresponding average output power. The absorber bias voltage was held constant at 5 V.

The possibility of wavelength tuning through the use of differential pumping was briefly explored. The center wavelength of operation was successfully shifted from 1246 nm to 1257 nm as can be seen in figure 7. Mode-locked operation was maintained during the transition but the quality of the mode-locked output was not verified at the time of this writing. The authors hope to demonstrate tunable continuous wave and mode-locked operation over this band by controlling the injection currents into the gain section and reverse bias voltage on the absorber. This would provide the possibility of a wavelength modulated output directly from the source without the need for external beam manipulation.

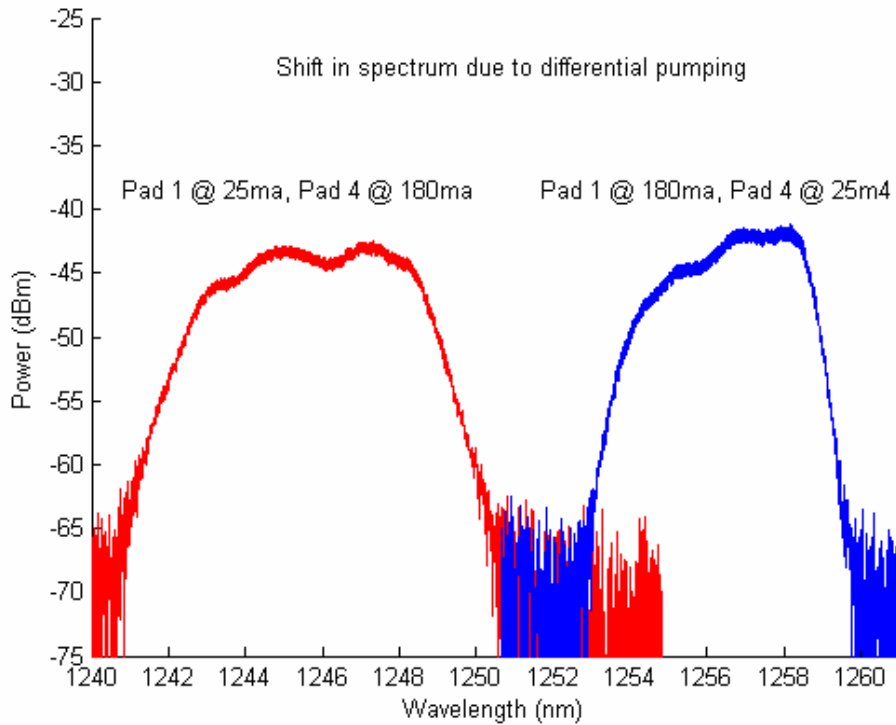

Figure 7: This plot shows the optical spectrums for two separate differential pumping schemes as applied to a single device. The total current was held constant while the amount entering pads 1 and 4 were reversed. The reverse bias was held at 3 V. The center frequency shifted nearly 12 nm.

### Conclusion

We have shown that the symmetry and breadth of a QD MLL's spectrum can be manipulated through differential gain pumping even though the pumped partitions were not electrically isolated. This provides a simple and inexpensive method of optimizing the semiconductor laser performance.

The regions of mode-locked operation with respect to injection current and absorber bias were shown to have a strong dependence on the location of the injected current within the gain medium and on the differential pumping scheme implemented. Significantly greater absorber bias voltages were available during differential pumping as compared to single pad current injection; thereby reducing absorber recovery time as well as the inferred pulse length. The enhanced spectral bandwidth provided by differential pumping offers still further pulse length reduction.

The capacity for wavelength tuning was also demonstrated by differential pumping with a center wavelength shift of approximately 12nm.

The techniques for spectral broadening and control, paired with the wavelength tunability demonstrated in this paper have many potential applications which include signal processing and waveform generation.



## References

1. Lei Zhang, Ling-Shen Chen, Allen L. Gray, Hua Huang, Srivasta P. G. Kuty, Hua Li, John Nagyvary, Faisal Nabulsi, Leonard Olona, Edwin Pease, Qi Sun, Chris Wiggins, John C. Zilko, Zhengzhong Zou, and Petros M. Varangis, "High-power low-jitter quantum-dot passively mode-locked lasers", *Physics and Simulation of Optoelectronic Devices XIV*, SPIE Vol. 6115
2. S. Melnik, G Huyet, "The linewidth enhancement factor of quantum dot semiconductor lasers," *Optics Express*, Vol. 14, NO. 7, April 2006
3. Yongchun Xin, "Quantum Dot Multi-section Light Emitters", PHD Dissertation, The University of New Mexico, December 2006
4. K. Brown, M. Fanto, D. Murrell, V. Kovanis, Y.-C. Xin and L.F. Lester, "Automated analysis of stable operation in two-section quantum dot passively mode locked lasers", SPIE Photonics West 2007, San Jose, California.